



INSTRUCTIONS D'ASSEMBLAGE
ASSEMBLY INSTRUCTIONS

MONARCH
SPECIALTIES INC.

I 3974

TABLE D'APPOINT -
24"H / BOIS PLAQUE ACAJOU FONCE

ACCENT TABLE -
24"H / DARK WALNUT VENEER END TABLE





POUR DE L'ASSISTANCE OU POUR COMMANDER
DES PIÈCES CONTACTEZ NOTRE DÉPARTEMENT
DE SERVICE À LA CLIENTÈLE.

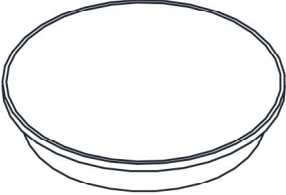
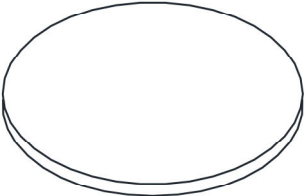

FOR ASSISTANCE OR TO ORDER PARTS
CONTACT OUR CUSTOMER SERVICE DEPARTMENT

WWW.MONARCHSERVICE.COM

LISTE DES PIÈCES
PARTS LIST

PIÈCE / PART #	IMAGE	DESCRIPTION	QTY / QTÉ
1		<p align="center">TABLE TOP SURFACE DE TABLE</p>	1
2		<p align="center">SHELF PANEL PANNEAU DE TABLETTE</p>	1
3		<p align="center">TABLE LEG PATTE DE TABLE</p>	3

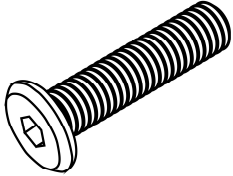
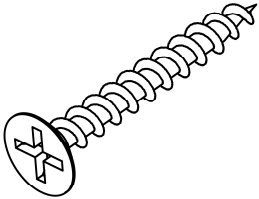
LISTE DES PIÈCES DE MONTAGE
HARDWARE LIST

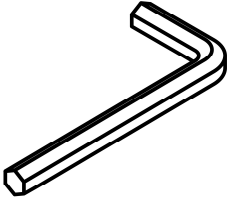
PIÈCE / PART #	IMAGE	DESCRIPTION	QTY / QTÉ
A		<p align="center">ASSEMBLING BOLT - 1/4" X 1 1/2"</p> <p align="center">BOULON D'ASSEMBLAGE - 1/4" X 1 1/2"</p>	6
B		<p align="center">ASSEMBLING SCREW - 1/8" X 1 1/8"</p> <p align="center">VIS D'ASSEMBLAGE - 1/8" X 1 1/8"</p>	3
C		<p align="center">FLOOR PROTECTOR</p> <p align="center">PROTECTEUR DE PLANCHER</p>	3
D		<p align="center">HEX KEY</p> <p align="center">CLÉ HEXAGONALE</p>	1



OUTIL DE VÉRIFICATION DE DIMENSIONS DES PIÈCES
HARDWARE DIMENSIONS VERIFICATION TOOL



ÉTAPE / STEP 1

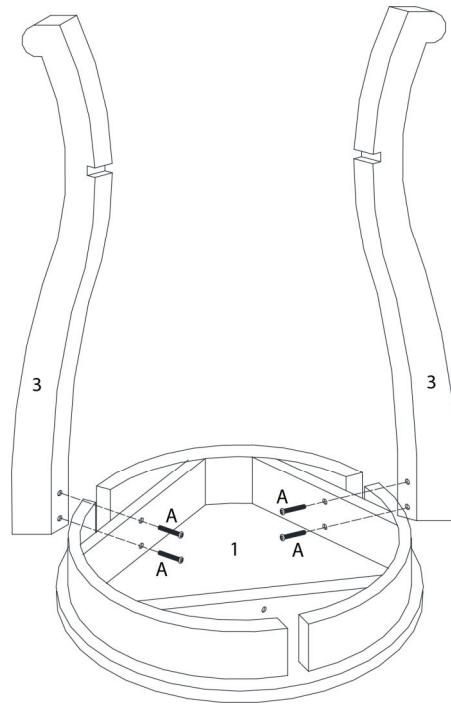

ÉTAPE / STEP 2

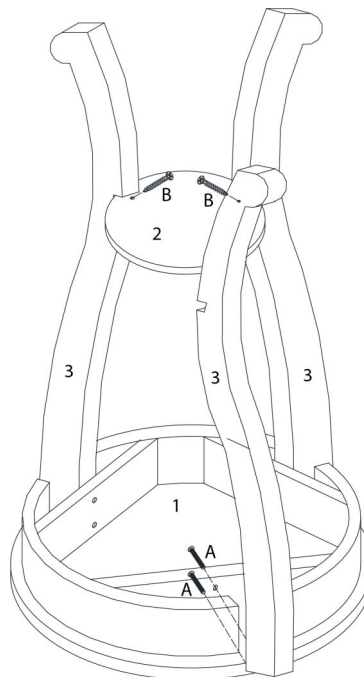

ÉTAPE / STEP 3

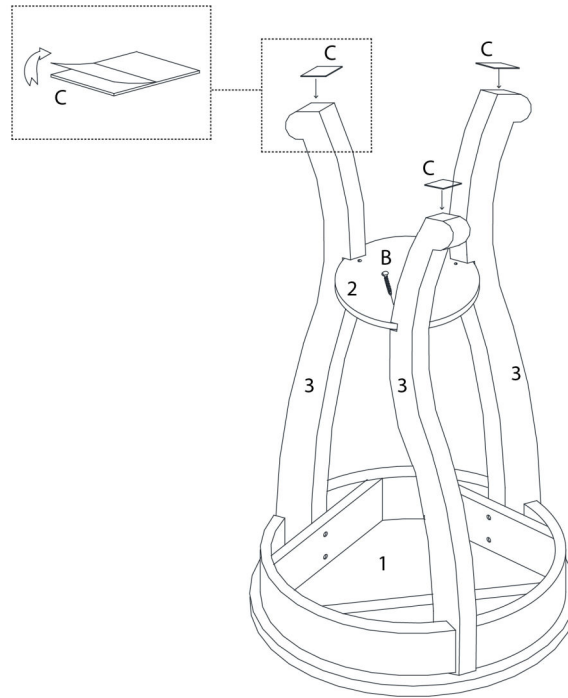

ÉTAPE / STEP 4

